

**INDUSTRIAL
GIGABIT ETHERNET
1000BASE-T TO 1000BASE-X
MEDIA CONVERTERS**

21.13.1144R (SX Model)

Installation Guide



DOC.071203-NCD-400

The information contained in this document is subject to change without prior notice. Copyright (C) All Rights Reserved.

TRADEMARKS

Ethernet is a registered trademark of Xerox Corp.

FCC NOTICE

This device complies with Class B Part 15 the FCC Rules. Operation is subject to the following two conditions: (1) This device may not cause harmful interference, and (2) this device must accept any interference received including the interference that may cause.

CE NOTICE

Marking by the symbol  indicates compliance of this equipment to the EMC directive of the European Community. Such marking is indicative that this equipment meets or exceeds the following technical standards:

EMC Class B

EN 50081-1/1992 : EN55022:1994/A1:1995/A2:1997 Class B

EN61000-3-2:2000

EN61000-3-3:1995/A1:2001

EN 55024:1998/A1:2001

IEC 61000-4-2:1995

IEC 61000-4-3:1995

IEC 61000-4-4:1995

IEC 61000-4-5:1995

IEC 61000-4-6:1996

IEC 61000-4-8:1993

IEC 61000-4-11:1994

Table of Contents

1. Introduction	5
1.1 Features	6
1.2 Specifications	7
1.3 Special Functions	11
2. Installation	13
2.1 Unpacking	13
2.2 Safety Cautions	14
2.3 DIN-Rail Mounting	15
2.4 Panel Mounting	17
2.5 Applying Power	19
2.6 Power Failure Relay Output	22
2.7 Making Twisted Pair Copper Port Connection	23
2.8 Making Fiber Port Connection	24
3 LED Indicators	25
3.1 LED Indicators	25
Appendix: Model Optical Specifications	26

1. Introduction

The industrial 1000BASE-T to 1000BASE-X media converter series provides industrial strength Ethernet copper-to-fiber media conversion, allowing for 1000Base-T-to-1000Base-X over multi-mode or optional single-mode fiber optical media.



For industrial environment, the converters are designed with the following enhanced features exceeding that of commercial media converters:

- High and wide operating Temperature
- Wide operating voltage range for DC power input
- Power input interface: Industrial screw terminal block and DC power jack for external commercial power adapter as option
- DIN rail mounting support for industrial enclosure
- Screw panel mounting support for industrial enclosure
- Industrial-rated Emission and Immunity performance

1.1 Features

- Gigabit copper to fiber conversion: 1000Base-T-to-1000Base-SX/LX over multimode or single-mode fiber
- SFP design : For flexibility, an SFP (Mini-GBIC) connector is provided for the fiber port to accommodate any type of SFP fiber transceiver when needed.
- Support full wire speed copper to fiber conversion
- Auto MDI/MDI-X detection function on the copper port
- Auto-negotiation support
- Plug and play : no configuration settings is required
- Link Fault Pass Through : this function allows link fault status passes through between copper link and fiber link transparently.
- Far End Fault function on fiber port
- Transparent conversion to any type of packet frame
- No packet length limitation
- Diversified mounting support : desktop mounting, wall mounting, optional Din-Rail support
- Low power consumption
- Two power interface type: screw terminal block and DC jack
- Wide operating voltage input range
- Support DIN rail mounting
- Support panel mounting
- High and wide operating temperature range
- Industrial-rated Emission and Immunity performance

1.2 Specifications

This figure shows the important components of the converter:

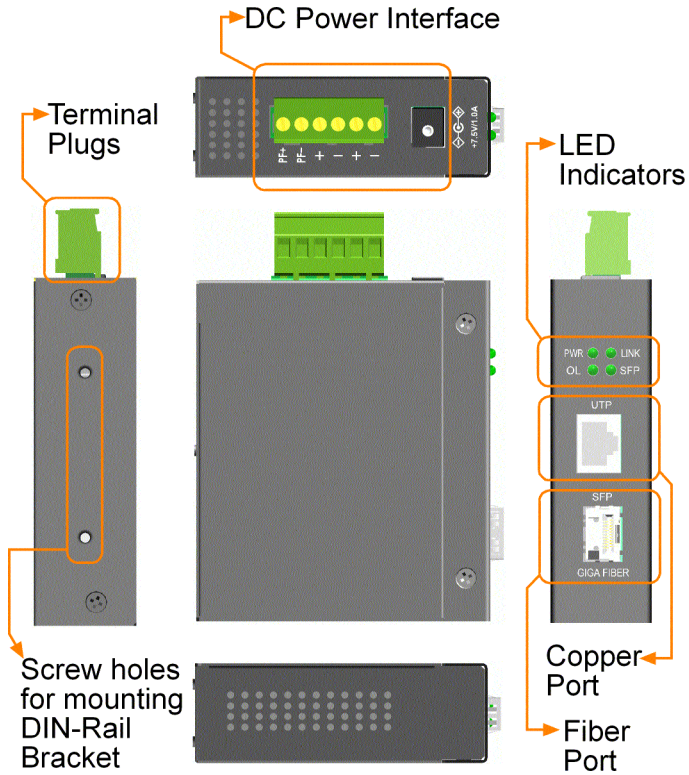

Twisted-Pair Interface (Copper Port)

Connector	Shielded RJ-45
Signal Compliance	IEEE 802.3ab 1000BASE-T std.
Pin Assignments	Auto MDI/MDI-X detection
Data Speed	1000Mbps
Duplex Mode	Half-duplex or Full-duplex
Configuration	Auto-negotiation support
Cable Types	Category 5 or higher UTP
Link Distance	Up to 100 meters

Fiber Optic Interface (Fiber Port)

Signal Compliance	IEEE 802.3z 1000BASE-SX/LX std.
Connector	SFP for pluggable fiber transceiver
Data Speed	1000Mbps
Duplex Mode	Full duplex
Cable Types	MMF - 50/125, 62.5/125 (SX Model) SMF - 9/125
Link Distance	MMF up to 500m (SX Model) SMF -model dependent
Eye Safety compliance	IEC825 Class 1

Refer to Appendix for detailed optical specifications.

LED Indicators

<u>LED</u>	<u>DISPLAY</u>	<u>STATE</u>	<u>INTERPRETATION</u>
PWR	Power status	ON	Power on
		OFF	Power off
SFP	SFP slot status	ON	SFP transceiver is installed.
		OFF	No SFP transceiver is installed.
LINK	Link status	ON	Copper-fiber link up
		OFF	Copper-fiber link down
		BLINK	Copper-fiber link with data traffic
OL	Optical status	ON	Fiber port optical signal detected
		OFF	Fiber port no optical signal

DC Power Interface

Interface	Screw-type terminal block 1. Two pairs for power wire cascading 2. One pair for power failure relay output
Operating Input Voltages	DC Jack (-D6.3mm/+D2.0mm) +7V ~ +30V(+5%)
Power consumption	2.25W @+7.5VDC input 2.3W @+24VDC input 2.5W @+30VDC input

Basic Information

Conversion	Full wire speed 1000Mbps - 1,488,00pps at 64-byte packets
Packet Types	Transparent and no modification for - IEEE 802.3 standard packets - IEEE 802.1Q VLAN tagged packets
Packet Length	No limit

Mechanical

Dimension (base)	W 28mm x D 82mm x H 95mm
Housing	Enclosed metal with no fan
Mounting Support	DIN-rail mounting, Panel mounting
Weight	252g

Environmental

Operating Temperature	Typical -20°C ~ 70°C (model dependent)
Storage Temperature	-20°C ~ 85°C
Relative Humidity	5% ~ 90%

Certificate

FCC	Part 15 Class B
CE/EMC	EMI EN50081-1 Class B
	EMS EN55024
CE/LVD Safety	EN 60950

EN 50081-1/1992 :

EN55022:1994/A1:1995/A2:1997

EN61000-3-2:2000

EN61000-3-3:1995/A1:2001

EN 55024:1998/A1:2001

IEC 61000-4-2:1995 ESD Test

IEC 61000-4-3:1995 RS Test

IEC 61000-4-4:1995 EFT/BURST Test

IEC 61000-4-5:1995 Surge Test

IEC 61000-4-6:1996 CS Test

IEC 61000-4-8:1993 Magnetic Field

IEC 61000-4-11:1994 Volatge Int. Dips

1.3 Special Functions

Auto MDI/MDI-X Function

This function allows the copper port to auto-detect the twisted-pair signals and adapts itself to form a valid MDI to MDI-X connection with the remote connected device automatically.

Link Fault Pass Through Function

When a link fault is detected on the copper port, the device will force a link down on the fiber port immediately. Similarly, a link fault detected on the fiber port will also force a link down on the copper port. As illustrated in the following figure, this function allows to pass copper link fault to the remote link partner and makes the converter like a twisted pair cable extender.

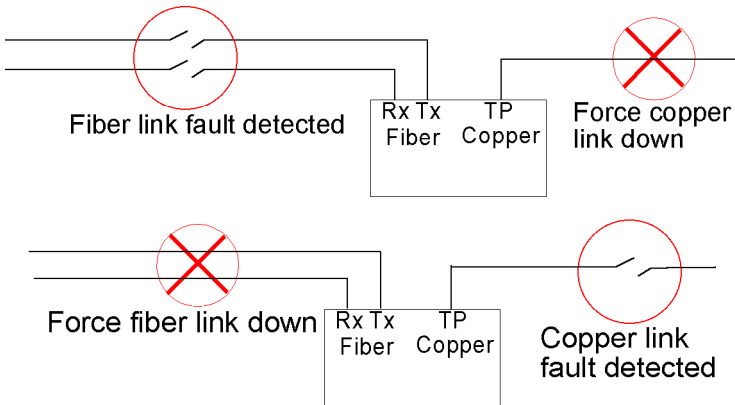

Far End Fault Function

The fiber port is facilitated with this function. When the fiber port detects a link failure on its receiving circuitry, it will send out an FEFI (Far End Fault Indication) signal to the remote connected device to indicate a remote fault is detected.

It also is capable to receive FEFI signal sent from the remote link partner if the link partner detected a receiving fault. Upon receiving an FEFI signal, it indicates a link failure occurred on the transmitting path. This function allows the converter to report a fiber link fault even when a link failure occurred on transmitting fiber cable.

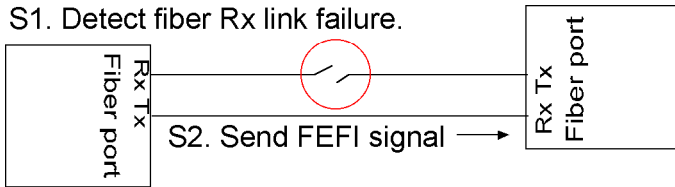

Finally, fiber ports on both devices are link down.

2. Installation

2.1 Unpacking

Check that the following components have been included:

- Information CD
- The Media Converter unit
- DIN-rail mounting bracket

If any item is found missing or damaged, please contact your local reseller for replacement.

The following are available optional accessories:

- Panel Mounting Bracket
The bracket is used for mounting the converter on a panel surface.
- Commercial-rated AC power adapters:
 - Rated AC120V/60Hz DC7.5V 1A
 - Rated AC230V/50Hz DC7.5V 1A
 - Rated AC100V/50-60Hz DC7.5V 1A
 - Rated AC240V/50Hz DC7.5V 1A

The adapters are used for supplying DC power to the converter via DC power jack interface.

2.2 Safety Cautions

To reduce the risk of bodily injury, electrical shock, fire, and damage to the equipment, observe the following precautions.

- Do not service any product except as explained in your system documentation.
- Opening or removing covers may expose you to electrical shock. Only a trained service technician should service components inside these compartments.
- If any of the following conditions occur, unplug the product from the electrical outlet and replace the part or contact your trained service provider:
 - The power cable, extension cable, or plug is damaged.
 - An object has fallen into the product.
 - The product has been exposed to water.
 - The product has been dropped or damaged.
 - The product does not operate correctly when you follow the operating instructions.
- Do not push any objects into the openings of your system. Doing so can cause fire or electric shock by shorting out interior components.
- Operate the product only from the type of external power source indicated on the electrical ratings label. If you are not sure of the type of power source required, consult your service provider or local power company.

2.3 DIN-Rail Mounting

In the product package, a DIN-rail bracket is installed on the device for mounting the converter in a industrial DIN-rail enclosure.

The steps to mount the device onto a DIN rail are:

1. Install the mounting bracket onto the device unit as shown below:

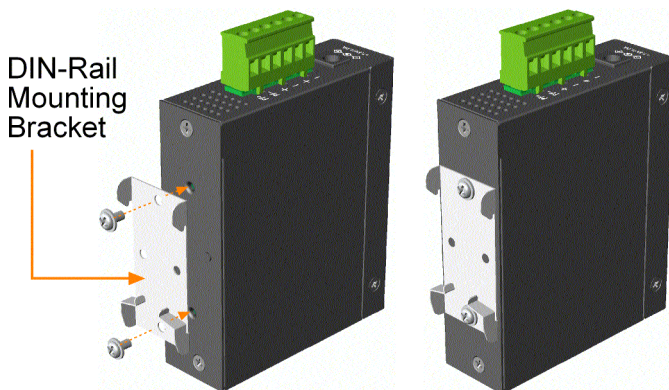

2. Attach bracket to the lower edge of the DIN rail and push the unit upward a little bit until the bracket can clamp on the upper edge of the DIN rail.
3. Clamp the unit to the DIN rail and make sure it is mounted securely.
4. Make sure that there are proper heat dissipation from and adequate ventilation around the device.

DIN-Rail

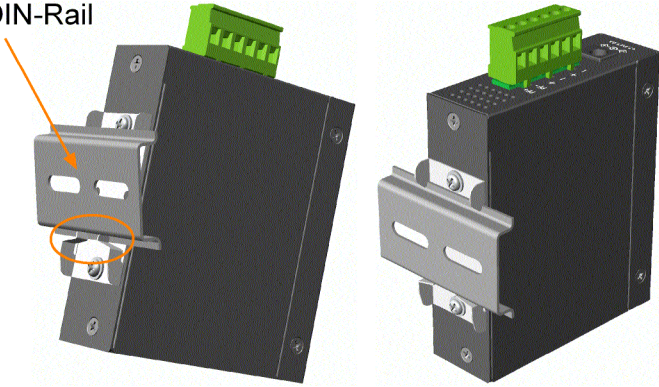

The final mechanical dimensions after installing DIN rail mounting bracket are:

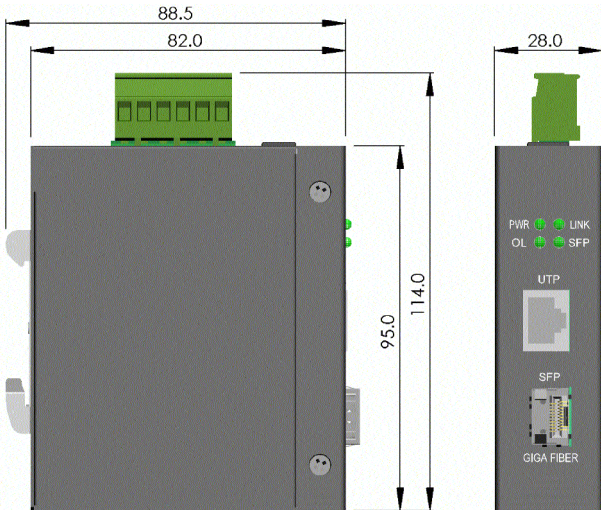

2.4 Panel Mounting

The device is provided with an optional panel mounting bracket. The bracket support mounting the device on a plane surface securely. The mounting steps are:

1. Install the mounting bracket on the device unit.
2. Screw the bracket on the device unit.

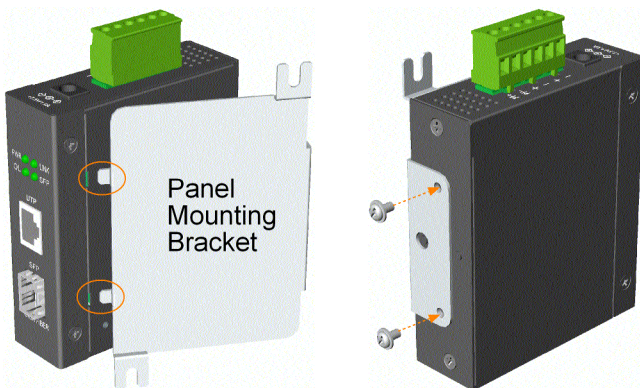

3. Screw the device unit on a panel.
4. Make sure that there are proper heat dissipation from and adequate ventilation around the device. Do not place heavy objects on the device.

The screw locations and final dimension are shown below:

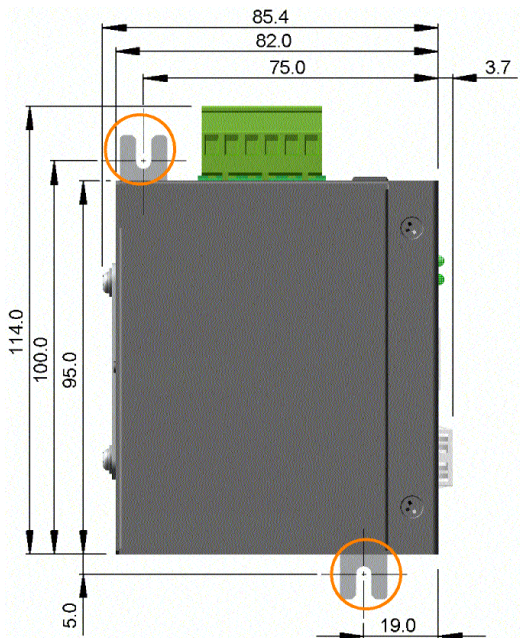

2.5 Applying Power

The power specifications of the device are:

Operating Voltage +7~+30VDC

Power Consumption Max. 2.5W @30VDC

The device provides two types of power interfaces, terminal block and DC power jack for receiving DC power input from external power supply.

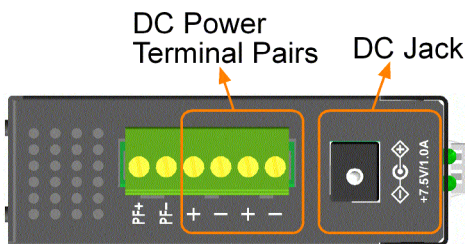

Using Terminal Blocks

Either DC1 interface or DC2 interface can be used to receive DC power from an external power system. Or, DC2 also can be used to deliver the power received on DC1 to next device in cascading way.

DC1 + Vdc Positive (+) terminal

DC1 - Vdc Negative (-) terminal

DC2 + Vdc Positive (+) terminal

DC2 - Vdc Negative (-) terminal

Three 2P terminal plugs are provided together with the device. Two of the three plugs are used for DC1 and DC2 interfaces respectively. The plug is shown below:



Power wires: 24 ~ 12AWG (IEC 0.5~2.5mm²)

Install the power source wires with the plug properly. Screw the wire with plug securely. Then, plug in DC1 contacts.

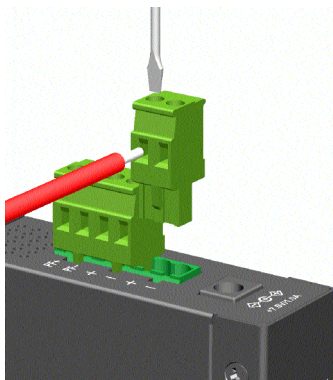

If cascading the power to next device is needed, install the power wires and plug for another switch. Then, use DC2 contacts.

Note: Only up to four device units can be cascaded to receive power from one main power input source.

Using DC Power Jack

DC Jack Connector: Jack D 6.3mm —  + D 2.0mm

AC Power Adapters: Optional commercial rated adapters are available for purchasing.

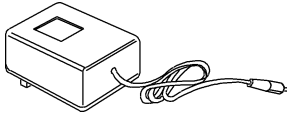

Rated AC120V/60Hz DC7.5V 1A

Rated AC230V/50Hz DC7.5V 1A

Rated AC100V/50-60Hz DC7.5V 1A

Rated AC240V/50Hz DC7.5V 1A

Connect power adapter DC plug to the DC power jack of the converter before connecting to the AC outlet. Connect the power adapter to the AC outlet.

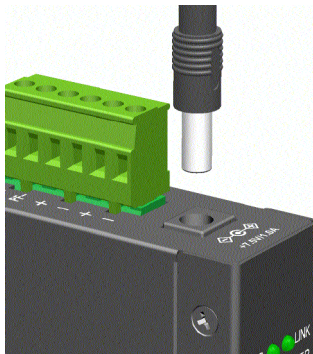

Note: Before you begin the installation, check the AC voltage of your area. The AC power adapter which is used to supply the DC power for the unit should have the AC voltage matching the commercial power voltage in your area.

2.6 Power Failure Relay Output

The device provides a relay output to report power failure event to a remote alarm monitoring system. The relay output is provided with two contacts labeled **PF+** and **PF-** in the terminal block interface.

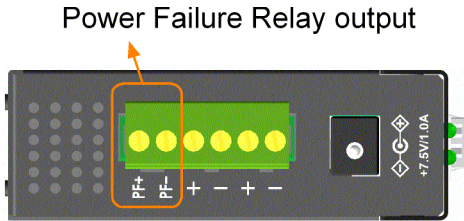

Use the provided 2P terminal plug for signal wiring and plug into the PF+/- contacts. The function is designed as :

Power is normal PF+ contact is shorted with PF- contact.

Power failure PF+ contact is disconnected with PF- contact.

Note: Be sure the voltage applied on PF+/- contacts is within the specification of 30VDC/1A max. or 120VAC/0.5A max.

2.7 Making Twisted Pair Copper Port Connection

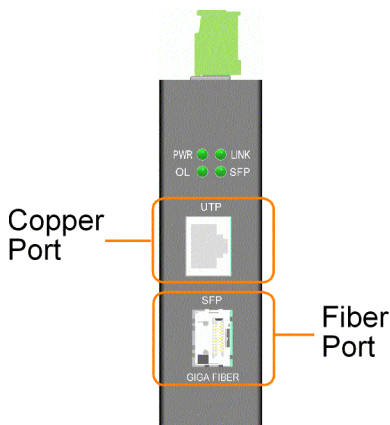

Copper port is featured to support connection to :

- Auto-negotiation devices
- Auto-negotiation incapable 10BASE-T devices
- Auto-negotiation incapable 100BASE-TX devices

Network Cables

1000BASE-T: 4-pair UTP Cat. 5e or 6, EIA/TIA-568B 100-ohm STP
Link distance: Up to 100 meters

Note: The copper port is featured with auto MDI/MDI-X crossover detection and configuration function. No matter a straight through cable or crossover cable is connected, the copper port can sense the receiving pair automatically and configure itself to match the connection.

2.8 Making Fiber Port Connection

The mini-GBIC (SFP) port must be installed with an SFP fiber transceiver for making fiber connection. The device may come with an SFP transceiver pre-installed when it is shipped from factory.

Installing SFP Fiber Transceiver

Turn off the power to the device. Insert the SFP fiber transceiver into the mini-GBIC port. Normally, a bail is provided for every SFP transceiver. Hold the bail and make insertion. Until the SFP transceiver is seated securely in the slot, place the bail in lock position.

Connecting Fiber Cables

LC connectors are commonly equipped on most SFP transceiver modules. Identify TX and RX connector before making cable connection. The following figure illustrates a connection example between two fiber ports:

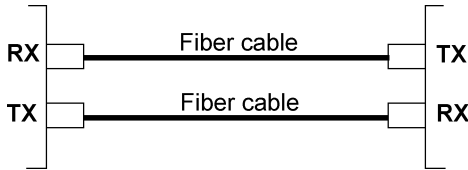

Make sure the RX-to-TX connection rule is followed on the both ends of the fiber cable.

Note: For Bi-Di (Bidirectional) SFP transceivers which use two different wavelengths for TX and RX respectively over single fiber cable, only one connector is provided on the fiber port and only one fiber cable is used.

Network Cables

Multimode (MMF) - 50/125, 62.5/125 (SX Model)

Single mode (SMF) - 9/125

3 LED Indicators

The following figure shows the locations of the configuration switches and LED indicators:

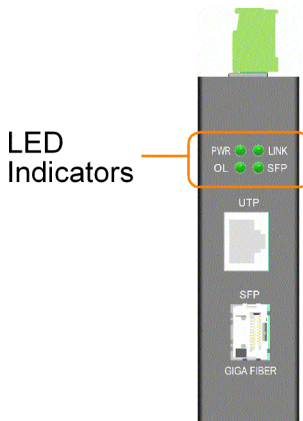

3.1 LED Indicators

<u>LED</u>	<u>DISPLAY</u>	<u>STATE</u>	<u>INTERPRETATION</u>
PWR	Power status	ON	The device is powered on.
		OFF	The device is powered off.
SFP	SFP slot status	ON	An SFP transceiver is installed.
		OFF	No SFP transceiver is installed.
LINK	Link status	ON	Copper-fiber link up
		OFF	Copper-fiber link down
		BLINK	Copper-fiber link with data traffic
OL	Optical status	ON	Fiber port optical signal detected
		OFF	Fiber port no optical signal

Appendix: Model Optical Specifications

The media converter series provides the following fiber options:

Model Specifications

<u>Converter-xx</u>	<u>FX</u>	<u>Wavelength</u>	<u>Reference</u> <u>Fiber Distance</u>	<u>Operating</u> <u>Temperature</u>
SX Model	LC	850nm	50/125 MMF 500m 62.5/125 MMF 200m	-20 ~ 70°C
LX Model	LC	1310nm	MMF 550m SMF 10km	-20 ~ 70°C
LX20 Model	LC	1310nm	SMF 20km	-20 ~ 70°C

Optical Specifications

<u>Converter-xxx</u>	<u>FX</u>	<u>Tx Power</u>	<u>Sensitivity</u>	<u>Max. Rx Power</u>
SX Model	LC	-9.5 ~ -4 dBm	-18dBm	-1 dBm
LX Model	LC	-9.5 ~ -3 dBm	-20dBm	-3 dBm
LX20 Model	LC	-8 ~ -2 dBm	-23dBm	-1 dBm